

DLH DS 8 H16 FG180.280BR GALCU (204 107)

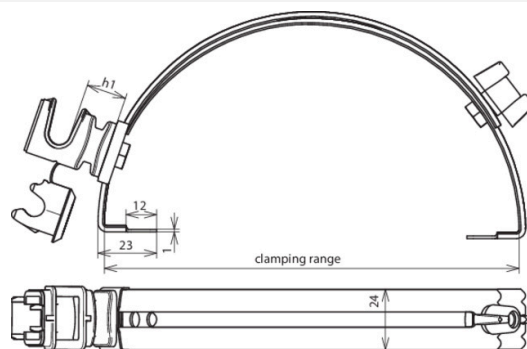

Figure without obligation



Type	DLH DS 8 H16 FG180.280BR GALCU
Part No.	204 107
Material of roof conductor holder	Cu
Clamping range	180-280 mm
Height of conductor holder (h1)	16 mm
Material of conductor holder	plastic
Colour of conductor holder	brown •
Conductor support Rd	8 mm
Length of clamping claw	23 mm
Type of conductor holder	DEHNsnap
Conductor routing	loose
Application note	conductor leading (support) laterally adjustable
Female thread	M6
Weight	105 g
Customs tariff number (Comb. Nomenclature EU)	85389099
GTIN	4013364028104
PU	25 pc(s)

We reserve the right to introduce changes in performance, configuration and technology, dimensions, weights and materials in the course of technical progress. The figures are shown without obligation.